

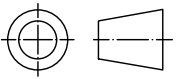

Title: clear anodised		Article number: 103453	
Description: L=2000 mm		Material: Aluminum 6063-T5	
Scale: 5:1	America	Tolerance: 25=±0,5 25,0=±0,05	
Date: 18-4-2017	Projection: 	Format: A4	
Dimension: mm	Weight: 0,668 kg	MakerBeam	